

CT3044 Ceiling mount turn

Article number (SKU) 7950104
 Colour Silver

Key Benefits

- Stylish high-end design
- Cable management
- Quick and easy installation

Ceiling mount kit CT3044

Display size: Fitment: 400x400Max. load: 80 kg - 176 lbs Kit consists of: • 1x PUC 1065 Ceiling plate turn • 1x PUC 2530 Pole 300 cm • 1x PFB 3405 Interface bar • 1x PFS 3304 Interface display strips

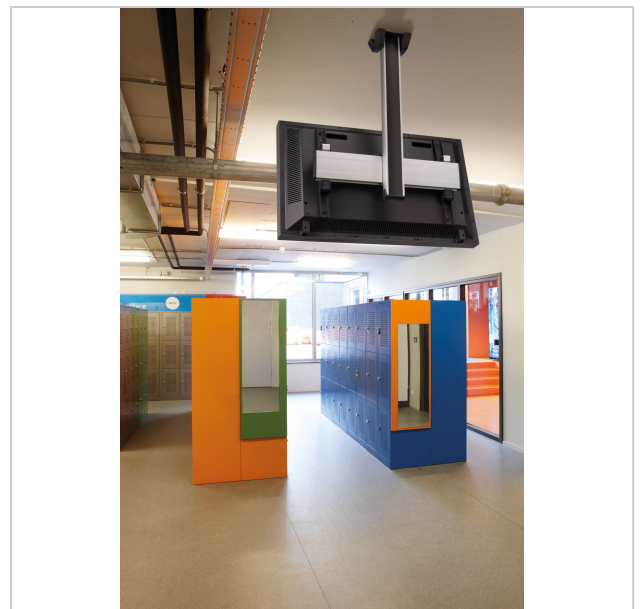
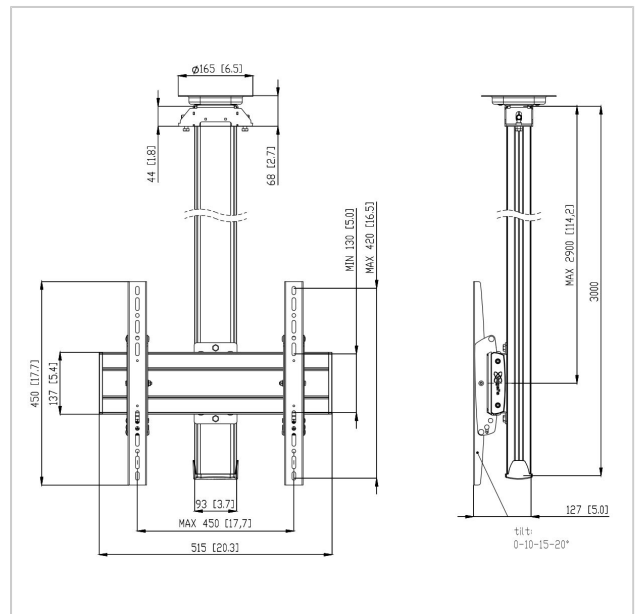

CT3044 Ceiling mount turn



VOGEL'S HOLDING BV 2019 (c) All rights reserved.
Subject to printing errors, technical and price amendments.
Date:2020-08-26

www.vogels.com

Specifications

Product type number	CT3044	Min. horizontal hole pattern (mm)	100
Article number (SKU)	7950104	Min. vertical hole pattern (mm)	100
Colour	Silver	Universal or fixed hole pattern	Universal
EAN single box	8712285332463		
Length	3000		
Width	515		
Depth	127		
TÜV certified	Yes		
Tilt	Tilt up to 20°		
Turn	Up to 360°		
Guarantee	5 years		
Max. weight load (kg)	80		
Min. hole pattern	100mm x 100mm		
Max. hole pattern	450mm x 420mm		
Max. bolt size	M8		
Max. height of interface (mm)	450		
Max. width of interface (mm)	515		
Autolock	True		
Ceiling types	Flat ceiling		
Fischer inside	Yes		
Max. distance to ceiling - center display (mm)	2900		
Max. horizontal hole pattern (mm)	450		
Max. screen size (inch)	65		
Max. vertical hole pattern (mm)	420		