

MOMO 2127 Monitor Arm Motion (black)

Article number (SKU): 7121270
Colour: Black

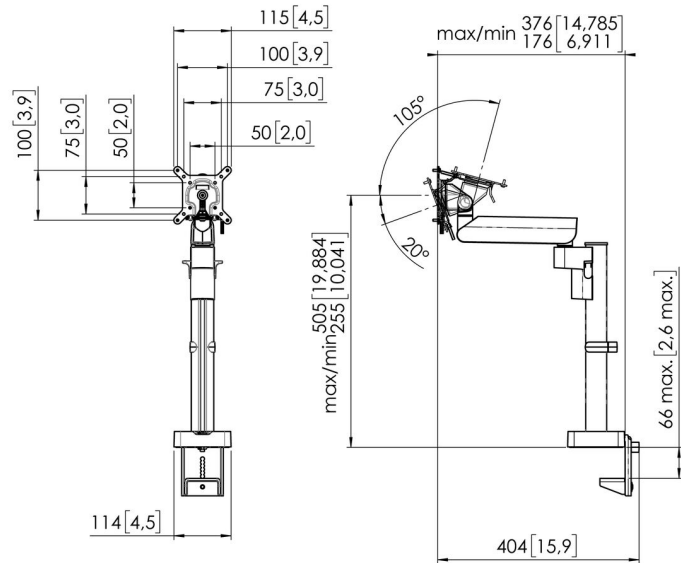

Tender specifications

BRAND AND PRODUCT; Vogel's MOMO MOTION 2127; Monitor Mount on a pole; colour: black/white; suitable for one monitor MARKET SEGMENTATION: Monitor Mounts ideal for use in a school, meeting room, lobby or boardroom; offices; market segment education; corporate; retail; hospitality SUITABLE FOR: Suitable for monitors up to 43 inch; Max. weight of monitor 20 kg/44 lbs; MATERIALS: adjustable arms aluminium; asa cover caps according to RoHs guidelines; FEATURES: TÜV-3 tested; endurance test of at least 10,000 cycles; FIRA; IGR; warranty 10 years; easy installation from the top of the desk; universal interface suitable for any brand of monitors up to 43 inch; weighing up to 20 kg / 44 lbs; 2 pivot points; on/through desk; 250 mm height adjustment; Max height center monitor 505 mm; Thickness desk 66 mm; VESA size; 50x50/75x75/100x100; sivel 180; rotate 90/90; tilt -20/+105; rotation stop yes; environment-friendly packaging entirely without EPP | EPS; special MOMO accessories and components available for MOMO Monitor Mounts; TECHNICAL SPECIFICATIONS: Min. VESA 50x50mm Max. VESA 100x100; Height adjustment 250mm; Rotation stop yes; Mounting possibilities on or through desk; Adjustable height 250 mm; Max weight load 20kg/44 lbs; TUV-3 certified; MOMO Motion; LOGISTICS INFORMATION: box dimensions (mm) 707 x 199 x 135 (LxWxH); gross weight 4,96 kg / 10,93 lbs (warehouse) 9; PRODUCT PROPOSITION: Vogel's MOMO The Monitor Mount that works everywhere; Vogel's Products BV.



Article number (SKU): 7121270
Colour: Black

Key Benefits

- Height Adjustable
- Suitable for one, two or a whole series of monitors
- Easy install
- Flexible modular system
- TÜV certified / 10-year guarantee

The ergonomic monitor arm for every workplace The MOMO 2127 is a monitor arm specially designed for height-adjustable monitors. The monitor arm is suitable for monitors up to 43 inches and weighing up to 20 kg.



Sustainability is a key component of the MOMO Series. Vogel's offers an endurance tested design of the Monitor Mounts of over 10,000 cycles. No EPP | EPS is used in the packaging. Packaging is 100% recyclable.

VOGEL'S HOLDING BV (©)

All rights reserved.
Subject to printing errors, technical and price amendments.

Date: 2024-03-26