



CT240811 B Display Ceiling Mount

Key Benefits

- Stylish high-end design
- Easy install
- Rotatable

Ceiling mount kit CT240811

Display size: Fitment: 100x100Max. load: 30 kg - 66 lbs Kit consists of: • 1x PUC 1045 Ceiling plate turn and tilt • 1x PUC 2408 Pole 80 cm • 1x PFI 3015 Display interface

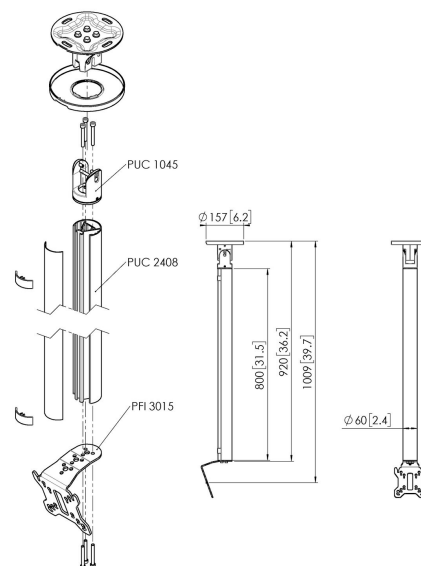



CT240811 B Display Ceiling Mount



Specifications

Min. screen size (inch)	10
Max. screen size (inch)	32
Min. horizontal hole pattern (mm)	50
Max. horizontal hole pattern (mm)	100
Min. vertical hole pattern (mm)	50
Max. vertical hole pattern (mm)	100
Universal or fixed hole pattern	Fixed
Max. height of interface (mm)	141
Max. width of interface (mm)	130
Max. distance to ceiling - center display (mm)	1009
Max. weight load (kg)	30
Max. weight load (Lbs)	66.14
Ceiling types	Flat / inclined ceiling
Turn	Up to 360°
Tilt	Tilt up to 20°
Orientation	Landscape / Portrait
Height options	Fixed height
Levelling function	Post-installation horizontal levelling
Length	920
Width	130
Depth	135
Article number (SKU)	7955010
EAN single box	8712285346880
Colour	Black
Certifications	TÜV
TÜV certified	Yes
Guarantee	5 years

VOGEL'S HOLDING BV (©)

All rights reserved.
Subject to printing errors,
technical and price
amendments.

Date: 2025-05-29



Vogel's. For Sure.