



MOMO 2137 Monitor Arm Motion (black)

Key Benefits

- Height Adjustable
- Suitable for one, two or a whole series of monitors
- Easy install
- Flexible modular system
- TÜV certified / 10-year guarantee

The ergonomic monitor arm for every workplace The MOMO 2137 is a monitor arm specially designed for height-adjustable monitors. The monitor arm is suitable for monitors up to 43 inches and weighing up to 20 kg.

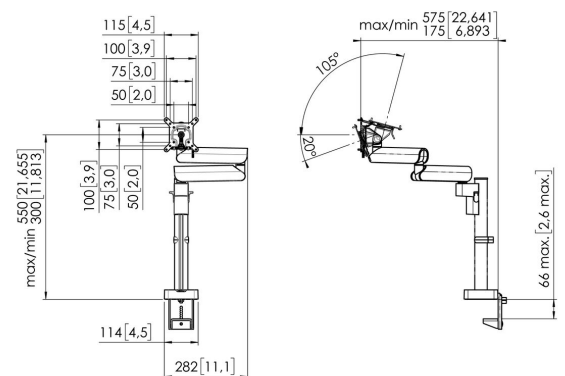



MOMO 2137 Monitor Arm Motion (black)



Specifications

Min. screen size (inch)	10
Max. screen size (inch)	43
Max. screen size (inch)	43
Universal or fixed hole pattern	Fixed
Max. height of interface (mm)	115
Max. width of interface (mm)	115
Max. weight load (kg)	20
Max. weight load (Lbs)	44.09
Max. center display	550
Max. thickness desk	66
Turn	Up to 180°
Number of pivot points	3
Rotate	Up to 180°
Tilt	Tilt -20°/+105°
Height adjustment	Manual operated
Adjustable depth	Yes
Adjustable height	Yes
Mounting Possibilities	On and through desk
Article number (SKU)	7121370
EAN single box	8712285353826
Colour	Black
TÜV certified	Yes
Guarantee	10 years

VOGEL'S HOLDING BV (©)

All rights reserved.
Subject to printing errors,
technical and price
amendments.

Date: 2024-01-03



Vogel's. For Sure.