



TVM 3843 Full-Motion TV Wall Mount (black)

Transparency regarding the footprint of our products is very important to us at Vogel's. We care for the environment and are working hard to make our products and the production process more sustainable. This footprint ecosheet provides an overview of the environmental footprint of this specific product to give you insight.

All impacts have been converted to the Global Warming Potential (GWP). This is the impact the product has on climate change expressed in kg CO₂ equivalent.

Vogel's. For Tomorrow.

Database:
Publishing date:

Ecoinvent 4.0
2024-04-26



Footprint ecosheet

81%

of this product is
RECYCLABLE

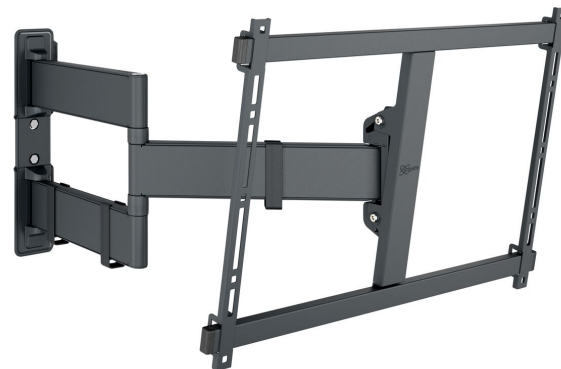

19,0 kg CO₂ eq.

compares to

57 km

of car driving

To explain the GWP in a comprehensible manner, we compared it to car driving. For the average European car driving 3,03 km equals 1 kg CO₂ eq. (source: Ecoinvent 3.8).

Manufacturing & materials

We minimize material use and use the impacts values as input for design decisions.

All impact related to manufacturing the product, including the extraction of raw materials, are included. Plastic components all have material marking for recycling.

24,38 kg CO₂ eq.

Transport

All transport from the production location to our European warehouse in Oss is included in the calculation.

To calculate the total impact of transport, please use the distance between the location of use and our warehouse. Multiply those numbers with the impact of truck transport per kilometer (numbers on the next sheet).

1,89 kg CO₂ eq.

Installation & use

We display the average energy use of power tools during installation. For our electrical products, we show the total energy use in the average total lifespan. Power usage of electrical devices attached to our products are not included in this footprint. Disposal of all packaging materials is included.

0,28 kg CO₂ eq.

End of life

Our product is prepared for standard recycling loops such as paper and metal recycling. Negative values indicate high recycling rates and are considered savings on GWP for future re-use in any form.

-7,58 kg CO₂ eq.



Ecological impact

Total Product GWP

19,0
Kg CO₂ eq

Detailed product footprint of TVM 3843 Full-Motion TV Wall Mount (black)



This footprint ecosheet provides detailed information of the environmental footprint of this specific product. The calculated emissions have been converted to kg CO₂ eq.

Manufacturing & materials

	Steel	Aluminium	Plastics	PAP	Wood	Other	Manufacturing
Weight in product	6791g	-	261g	1732g	-	1g	-
% of tot. weight	77,3%	-	2,97%	19,72%	-	0,01%	-
kg CO ₂ eq.	15,4	-	1,32	1,21	-	-	6,45

Transport

	Factory to warehouse	Warehouse to customer
kg CO ₂ eq.	1,89	0,001

Installation & Use

	Installation	Use	Packaging paper*	Packaging plastics*
kg CO ₂ eq.	0,004	-	0,27	0,01

End of life*

	Metals	Plastics	Woods and other
kg CO ₂ eq.	-7,76	0,18	-

*Impact based on average European recycling rates

	Metals	Paper & Cardboard	Plastics	Woods and other
Recycle	80%	95%	20%	-
Incineration	10%	3%	60%	-
Landfill	10%	2%	20%	-

Made with respect for people and the planet.

We use Life Cycle Assessment (LCA) software to fill in this footprint datasheet as accurately as possible. For our calculations we follow ISO 14021:2006 and ISO 14040:2006/14044:2006.