



MOMO 4127 Monitor Arm Motion Plus (black, CE)

Key Benefits

- Height Adjustable
- Suitable for one, two or a whole series of monitors
- Easy to assemble without tools
- Flexible modular system
- TÜV certified / 10-year guarantee

The ergonomic monitor arm for every workplace The MOMO 4127 is a dynamic monitor arm specially designed for monitors that are regularly adjusted in height, such as at flexible work stations. The monitor arm can bear screens up to 43 inches weighing up to 10 kg.

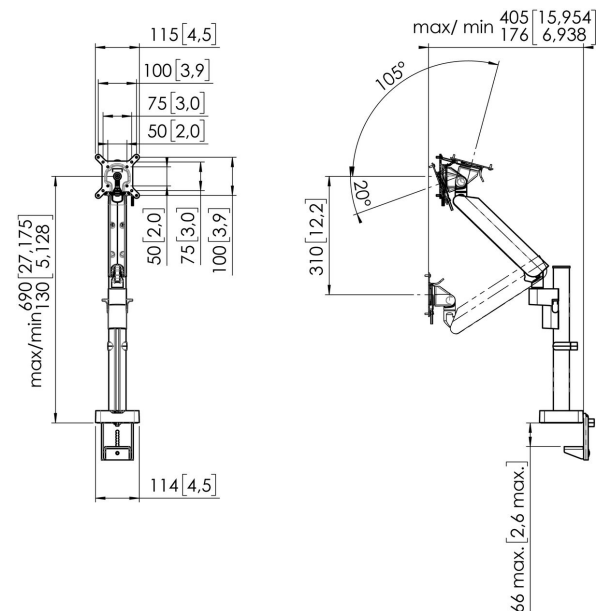



MOMO 4127 Monitor Arm Motion Plus (black, CE)



Specifications

Min. screen size (inch)	10
Max. screen size (inch)	43
Max. screen size (inch)	43
Universal or fixed hole pattern	Fixed
Max. height of interface (mm)	115
Max. width of interface (mm)	115
Max. weight load (kg)	10
Max. weight load (Lbs)	22.05
Max. center display	690
Max. thickness desk	66
Turn	Up to 180°
Number of pivot points	2
Rotate	Up to 180°
Tilt	Tilt -20°/+105°
Height adjustment	Mechanical spring, OneFingerMovement
Adjustable depth	Yes
Adjustable height	Yes
Mounting Possibilities	On and through desk
Article number (SKU)	07141270
EAN single box	8712285353581 (CE)
Colour	Black
TÜV certified	Yes
Guarantee	10 years

VOGEL'S HOLDING BV (©)

All rights reserved.
Subject to printing errors,
technical and price
amendments.

Date: 2023-12-05



Vogel's. For Sure.