

## RISE 5308 Motorized Display Lift Trolley 80 mm/s (black, EU)

**Article number (SKU): 7353080**  
**Colour: Black**

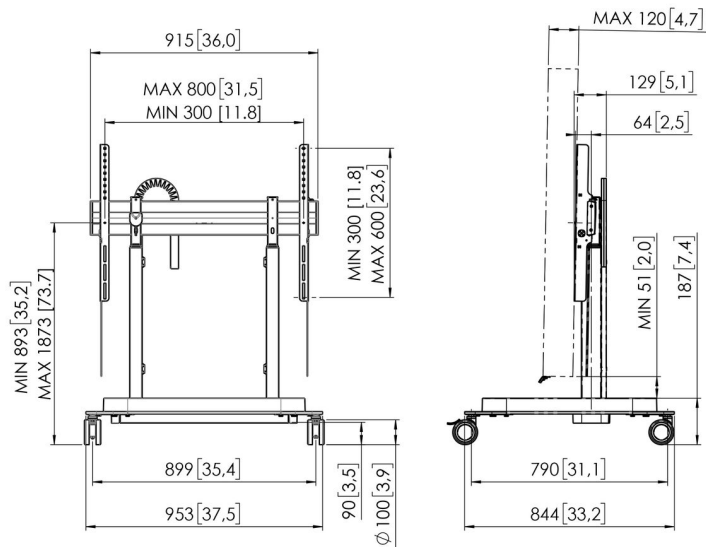

### Tender specifications

**BRAND AND PRODUCT:** Vogel's RISE 5308; motorized display lift; trolley wheels; colour: black; **MARKET SEGMENTATION:** motorized display lift ideal for use in a school, meeting room, lobby or boardroom; market segment education; market segment corporate; **SUITABLE FOR:** Suitable for (interactive, touchscreen) displays 65 inch to 98 inch; Max. weight of display 120 kg / 264.55 lbs; **MATERIALS:** lift console stainless steel; lift console black powder coated according to RoHs guidelines; engine exclusively developed for Vogel's; aluminium interface bar; 100 mm castors with double swivel head with non-streaking thermoplastic rubber strap; **FEATURES:** TÜV-5 tested; endurance test of at least 30,000 cycles; CE certificate; UL applied (2021); GS applied (2021); warranty 5 years; easy top-down assembly; universal interface suitable for any brand of interactive flat panel display upto 98 inch; lift speed 80mm/s with display upto 120 kg / 264.55 lbs; extra low position for children; specially designed base construction for extra safety; child-lock for lift movement; anti-collision protection when in contact with object lift moves in opposite direction; environment-friendly packaging entirely without EPP | EPS; special RISE accessories available for RISE display lifts; **TECHNICAL SPECIFICATIONS:** Min. VESA 300 x 300mm / 11.8 x 11.8 inch; Max. VESA 800 x 600 / 31.5 x 23.6 inch; Min.-Max. distance floor to centre display 893 - 1873 mm / 35.2 - 73.7 inch ; 980mm / 38.58 inch height adjustable; lift speed 80mm/s; depth from front to interface 446 mm / 70.56 inch; power supply 100-240v ~ 50/60Hz; rated current EU/ UK: 6A, US/CA: 15A; peripherals: Max. 900W; standby power consumption 0.5W; cable management included; 100mm double swivel castors; product height x width x depth, 1208 x 953 x 844 mm; net weight 41.1 kg / 90.61 lbs; **LOGISTICS INFORMATION:** box dimensions (mm) 951 x 743 x 234; gross weight 45.5 kg / 100.3 lbs ; pcs/pallet (CP5 in 40ft HC) 9; pcs/pallet (warehouse) 6; **PRODUCT PROPOSITION:** Motorized display lift for intuitive and safe use of a screen at the correct height; Vogel's Products BV.



**Article number (SKU): 7353080**  
**Colour: Black**



### **Key Benefits**

- Height adjustment range of no less than 980 mm
- Movement speed of 80 mm/s for the heaviest screens with QuickRise™
- TÜV and CE certified
- Specially designed foot for extra safety
- Integrated cable management (CIS®)

### **Screen moved smoothly and safely to the correct height**

A RISE 5308 motorized display and TV lift trolley is suitable for displays of up to 98" and 120 kg max. The lift raises the screen smoothly, quickly and safely at a speed of 80 mm/s with QuickRise™. With a 980 mm travel range the lift is suitable for both very low and high positions. The top-down assembly ensures quick installation. We offer a 5 year guarantee.

### **Safety first**

Vogel's display lift systems comply with the highest international safety standards of TÜV, CE, UL and GS. Although they are programmed for 86-inch screens, these motorized lift systems can be used for most 98" monitors. A small software adjustment (height adjustment) may occasionally be required (see user manual).

Sustainability is a key component of the RISE Series display lifts. Vogel's offers an endurance tested design of the display lift of over 30,000 cycles. No EPP | EPS is used in the packaging. There is also a reduction of 85% single used plastic in the packaging. This keeps waste streams to a minimum.

VOGEL'S HOLDING BV (©)

All rights reserved.

Subject to printing errors, technical and price amendments.

Date: 2023-06-30