



RISE 5105 Motorized Display Lift Floor Stand 50 mm/s (black, UK)

Key Benefits

- Height adjustment range of no less than 980 mm
- Movement speed of 50 mm/s for the heaviest screens with QuickRise™
- TÜV, CE, UL and GS certified
- Specially designed foot for extra safety
- Anti-collision on the display lift prevents damage

Adjust your display to the right height smoothly and safely

A RISE 5105 motorized display and TV lift floor stand is suitable for (interactive flat panel) displays up to 98" and 120 kg max. The lift tilts the screen at a speed of 50 mm/s smoothly and safely with QuickRise™. A travel range of 980 mm is suitable for very low or high positions. Safety first Vogel's display lifts comply with the international safety standards of TÜV, CE, UL and GS. The floor stand base is designed for extra safety during use. Although they are programmed for 86-inch screens, these motorized lift systems can be used for most 98" monitors. A small software adjustment (height adjustment) may occasionally be required (see user manual).

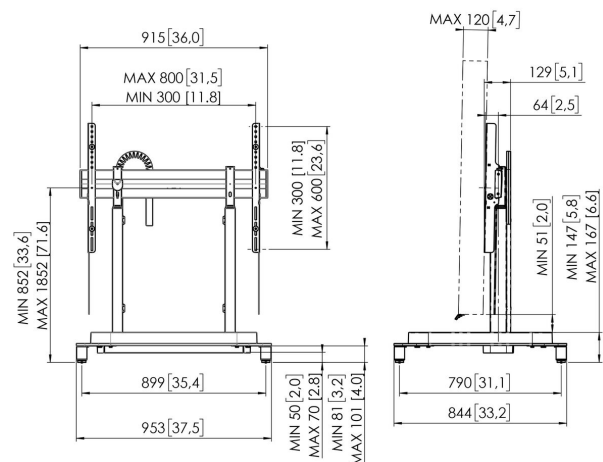



RISE 5105 Motorized Display Lift Floor Stand 50 mm/s (black, UK)



Specifications

Article number (SKU)	7351054
Colour	Black
EAN single box	8712285357626
Height	1188
Width	955
Depth	846
TÜV certified	Yes
Guarantee	5 years
Min. screen size (inch)	43
Max. screen size (inch)	98
Certifications	CE
Max. distance to floor - center display (mm)	1842
Max. horizontal hole pattern (mm)	800
Max. screen size (inch)	98
Max. vertical hole pattern (mm)	600
Min. distance to floor - center display (mm)	862
Min. horizontal hole pattern (mm)	300
Min. screen size (inch)	65
Min. vertical hole pattern (mm)	300
Motorized	Yes
Height adjustment (mm)	980

VOGEL'S HOLDING BV (©)

All rights reserved.
Subject to printing errors,
technical and price
amendments.

Date: 2023-07-04



Vogel's. For Sure.