

PUC 2718 Pole black

Article number (SKU)
Colour

7227180
Black

Key Benefits

- Cable management
- Modular

The poles are the connection between the floor base and display interface and are available in 3 different lengths, 150cm, 180cm and 200 cm. The poles are provided with a multiple cable management (CIS®) and can be combined with all Connect-it accessories. The PUC 27xx Series can only be used in combination with the floor solutions.

Vogel's Connect-it floor solutions (floor stands and trolleys) is an uniquely flexible system. With only a few standard components, you can create a solution for almost any requirement. From a single display floor stand in a shop window, a back-to-back display set-up in an airport, to a movable video conferencing set-up for corporate use, the flexible Connect-it floor solutions line fits every situation. Connect-it floor solutions can accommodate displays from small to extra large, weighing up to 160 kg. Connect-it floor modules are available in black and silver to fit any interior décor.

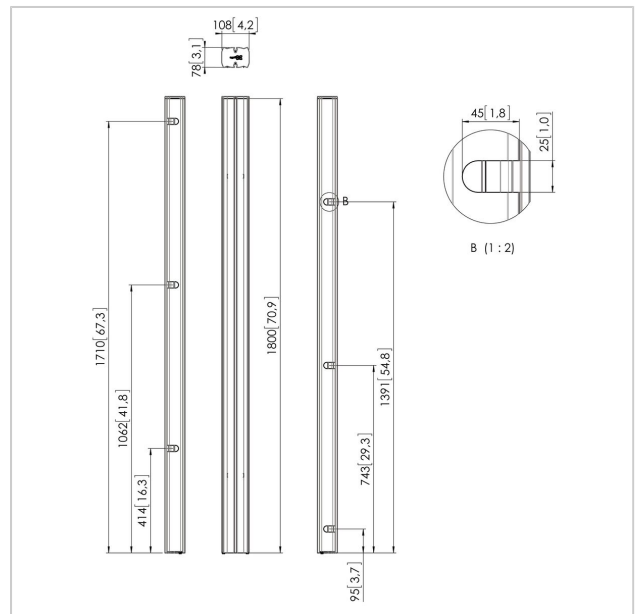



PUC 2718 Pole black

www.vogels.com

VOGEL'S HOLDING BV 2019 (c) All rights reserved.
Subject to printing errors, technical and price amendments.
Date:2020-03-19

Specifications

Product type number	PUC 2718
Article number (SKU)	7227180
Colour	Black
EAN single box	8712285323669
Length	1800
TÜV certified	Yes
Guarantee	5 years
Back-to-back displays	True
Connect It exceptions	2x if inches gte 65

