



RENTAL PRODUCT CATALOGUE

Innovative mounting
solutions for
displays and
projectors



TABLE OF CONTENTS

Product Catalogue 2024

GENERAL

Introduction 3

RENTAL

DISPLAY

DISPLAY - WALL-TRUSS MOUNTS..... 4

DISPLAY - FLOOR STANDS & TROLLEYS..... 6

Light Series Floor Stands & Trolleys 6

Heavy Duty Series Floor Stands & Trolleys 8

Stage Stands, Light and Heavy Duty Series 9

Display Hoister with flightcase 10

DISPLAY MOUNTS 14

PROJECTOR

PROJECTOR - TRUSS MOUNTS 18

Truss mounts with ball joint..... 19

Lightweight Truss Mounts with fine adjustment..... 20

Heavy Duty Truss Mounts with fine adjustment..... 21

PROJECTOR - STACK FRAMES..... 23

VOGEL'S

MOUNTING SOLUTIONS

In addition to the current range of Vogel's Pro-AV products, SmartMetals Mounting Solutions products are also offered and sold by the Vogel's Group. With this merging of product portfolios, we offer a complete range for the AV market, such as video wall solutions, electric display lifts, projector mounts, stack frames and rental solutions. We do this for various market segments. This way, we serve the market even better.



WALL-TRUSS MODULES

The display wall and truss solutions can be implemented in several ways: as a temporary installation of one flat panel, as a Video Wall solution with multiple displays, to a wall, in a truss or flying.

All solutions have been developed with focus on practicality and ease of use.

BENEFITS

- ✓ For portrait and landscape
- ✓ Quick and easy to install
- ✓ Easy alignment

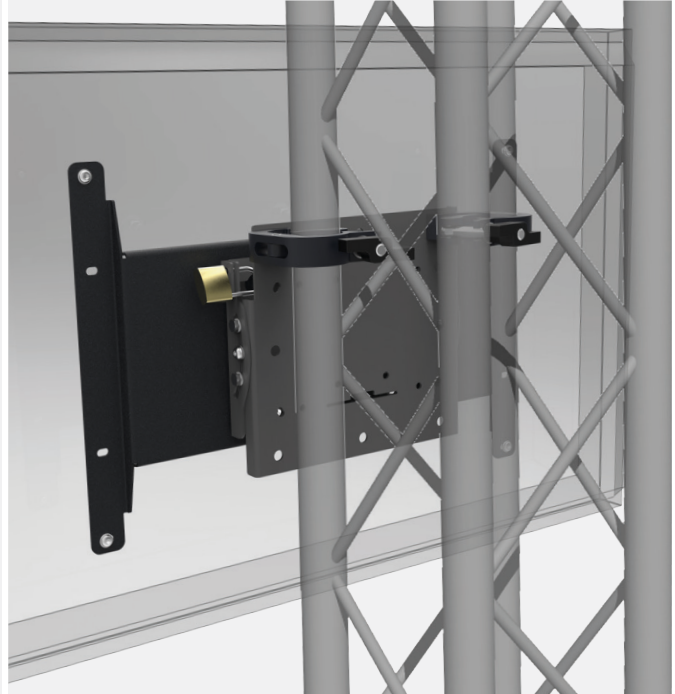

FIXED WALL-TRUSS MODULE FOR DISPLAY MOUNTS WITH THREE-POINT COUPLING

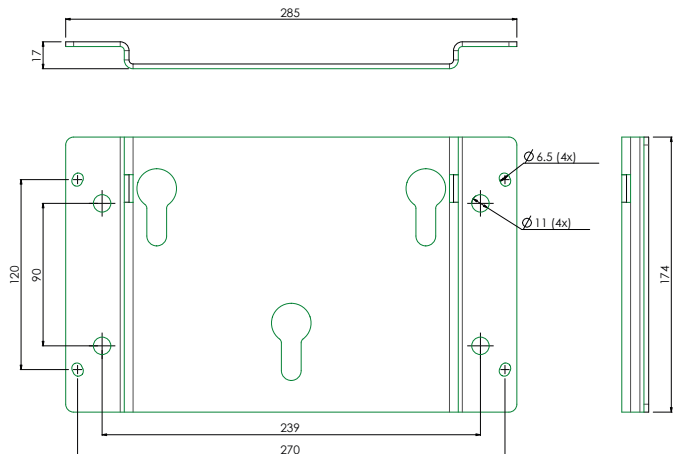
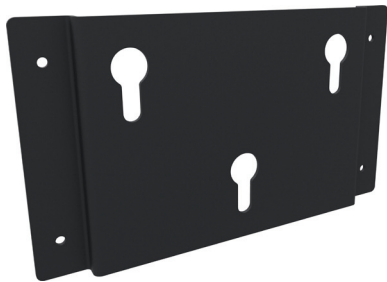

Article code

S063.0465



Colour



Max. load

80 kg



Position

Landscape & Portrait



Required



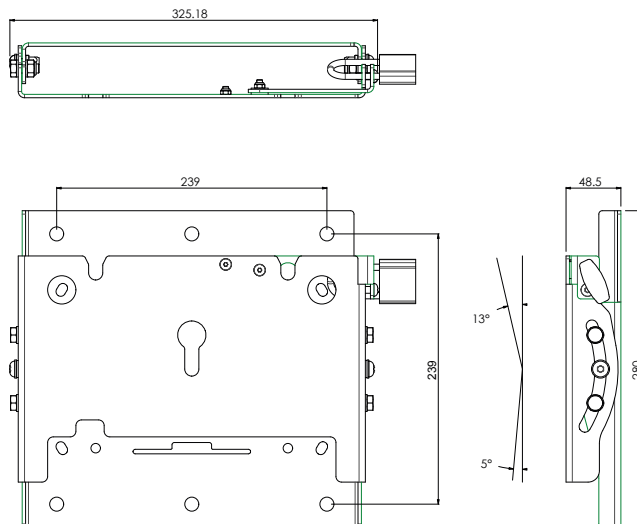
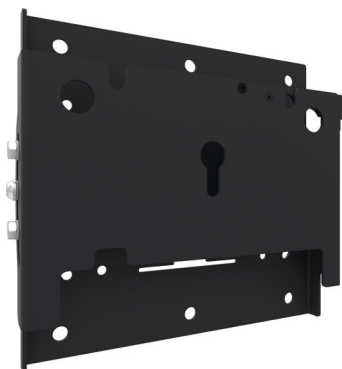

Display mount, see > page 14

TILTABLE WALL-TRUSS MODULE FOR DISPLAY MOUNTS WITH THREE-POINT COUPLING



Article code

S063.0460

| | | |
|---|-------------------|--|
|  | Colour | ● |
|  | Max. load | 80 kg |
|  | Position | Landscape & Portrait |
|  | Other info | Excl. Doughty trigger clamps (2x 003.1128) |



DOUGHTY TRIGGER CLAMP, MAX. 51 MM Ø

The Doughty Trigger Clamp is used for truss mounting with the SmartMetals rental mounts (002.16xx) and the wall-truss module (art. nr.: 063.0460).

Article code

S003.1128

ACCESSORY

FLOOR STANDS & TROLLEYS

LIGHT SERIES

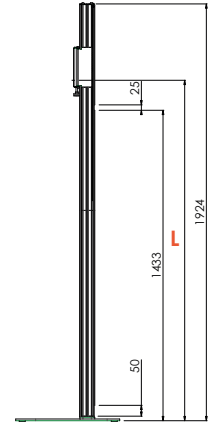
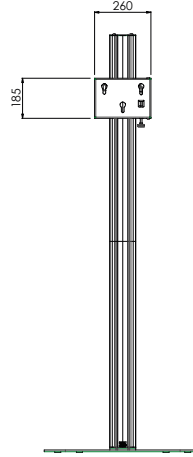
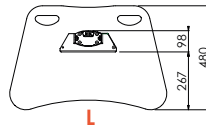
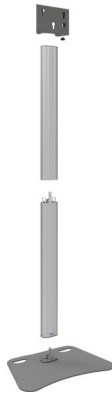

**DIVISIBLE DISPLAY FLOOR STAND
MAX. 55 INCH, 30 KG**

| | | |
|--|--------------------|------------------------------|
| | Colour | |
| | Max. load | 30 kg |
| | Max. inch | 55 inch |
| | Position | Landscape & Portrait |
| | Required | Display mount, see > page 14 |
| | Accessories | See page 11 |

| Article code | L (L) max. (centre display) | Base plate L (L) x W |
|----------------------|--------------------------------|-------------------------|
| S062.8050 | 1766 mm | 725 x 480 mm |
| S062.8050-225 | 2116 mm | 950 x 480 mm |

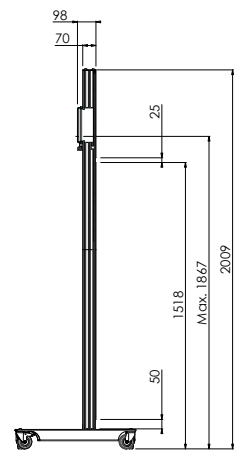
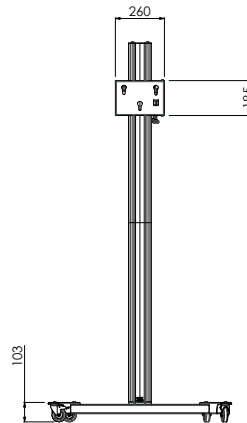
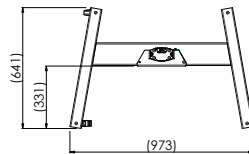
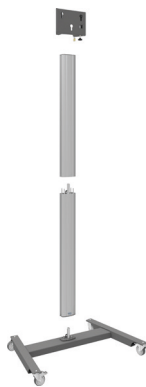





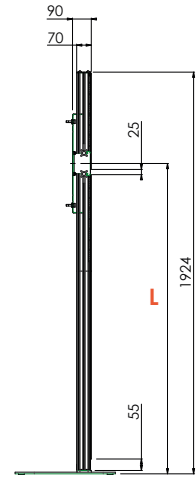
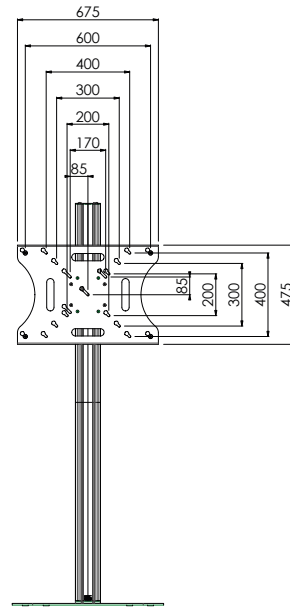
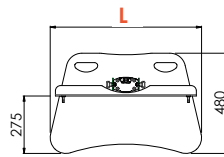
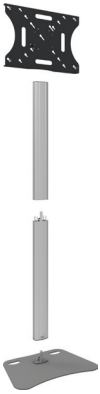

**DIVISIBLE DISPLAY TROLLEY
MAX. 55 INCH, 30 KG**

| | | |
|--|--------------------|------------------------------|
| | Colour | |
| | Max. load | 30 kg |
| | Max. inch | 55 inch |
| | Position | Landscape & Portrait |
| | Required | Display mount, see > page 14 |
| | Accessories | See page 11 |

| Article code |
|------------------|
| S062.8550 |



DIVISIBLE DISPLAY FLOOR STAND INCL. MOUNT MAX. VESA 600 X 400

| | | |
|---|--------------------|---|
|  | Colour |  |
|  | Max. load | 30 kg |
|  | Max. inch | 55 inch |
|  | Position | Landscape & Portrait |
|  | VESA | Max. VESA 600 x 400 |
|  | Accessories | See page 11 |

| Article code | L (L) max. (centre display) | Base plate L (L) x W |
|-----------------|--------------------------------|-------------------------|
| 062.8045 | 1486.5 mm | 725 x 480 mm |

FLOOR STANDS & TROLLEYS

HEAVY DUTY SERIES

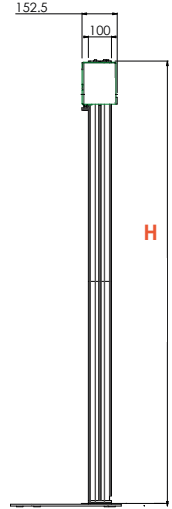
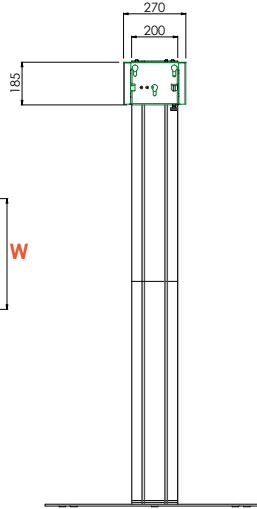
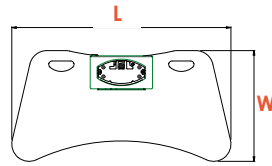
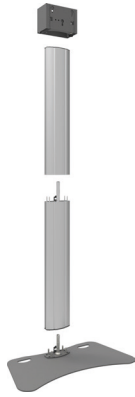

DIVISIBLE DISPLAY FLOOR STAND

| | |
|--------------------|------------------------------|
| Colour | |
| Position | Landscape & Portrait |
| Required | Display mount, see > page 15 |
| Accessories | See from page 12 |

| Article code | Max. load | Height (H) | Base plate L (L) x W (W) | Inch range |
|----------------------|-----------|------------|--------------------------|--------------|
| S062.1000 | 60 kg | 1929 mm | 950 x 480 mm | max. 65 inch |
| S062.3000 | 85 kg | 1929 mm | 1140 x 576 mm | max. 90 inch |
| S062.3000-225 | 85 kg | 2279 mm | 1140 x 576 mm | max. 90 inch |

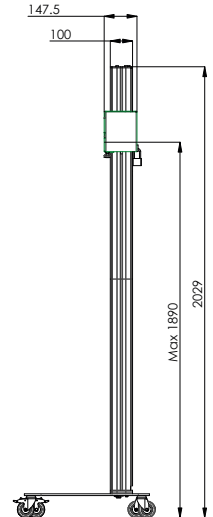
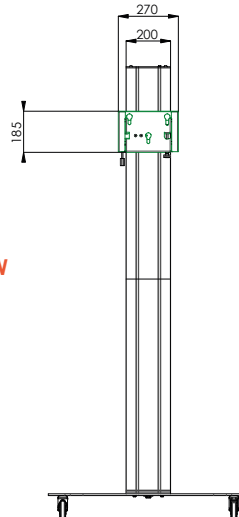
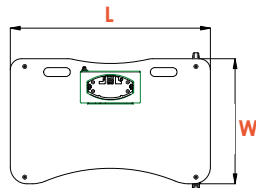
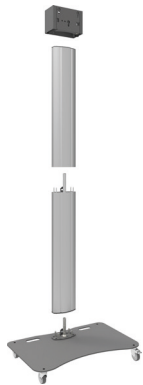

DIVISIBLE DISPLAY TROLLEY

| | |
|--------------------|------------------------------|
| Colour | |
| Position | Landscape & Portrait |
| Required | Display mount, see > page 15 |
| Accessories | See from page 12 |

| Article code | Max. load | Base plate L (L) x W (W) | Inch range |
|------------------|-----------|--------------------------|--------------|
| S062.1500 | 60 kg | 900 x 563 mm | max. 65 inch |
| S062.3500 | 85 kg | 1100 x 663 mm | max. 90 inch |

STAGE STANDS

LIGHT & HEAVY DUTY SERIES



LIGHT SERIES - DISPLAY STAGE STAND (EXCL. BASE PLATE)

| | | |
|--|--------------------|------------------------------|
| | Colour | <input type="radio"/> |
| | Max. load | 30 kg |
| | Max. inch | Max. 55 inch |
| | Position | Landscape & Portrait |
| | Required | Display mount, see > page 14 |
| | Accessories | See from page 11 |

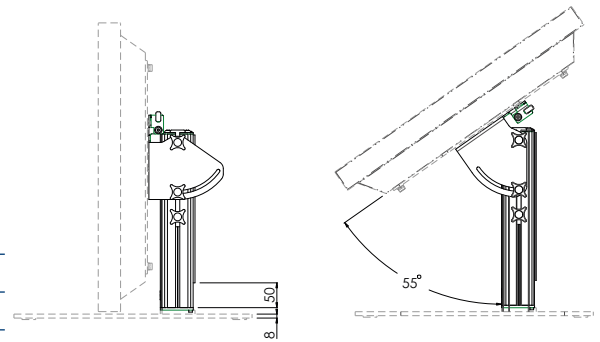
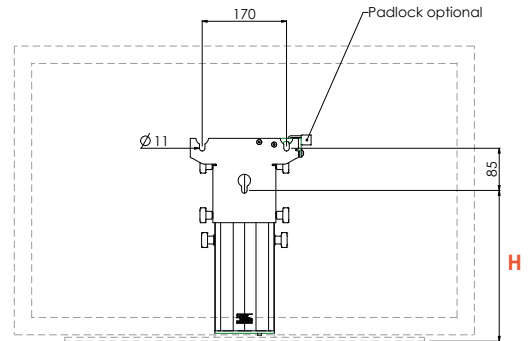

| Article code | Centre display (H) |
|------------------|--------------------|
| S063.8635 | 304 mm |
| S063.8695 | 904 mm |



HEAVY DUTY SERIES - DISPLAY STAGE STAND (EXCL. BASE PLATE)

| | | |
|--|--------------------|------------------------------|
| | Colour | <input type="radio"/> |
| | Max. load | 80 kg |
| | Max. inch | Max. 65 inch |
| | Position | Landscape & Portrait |
| | Required | Display mount, see > page 15 |
| | Accessories | See from page 12 |

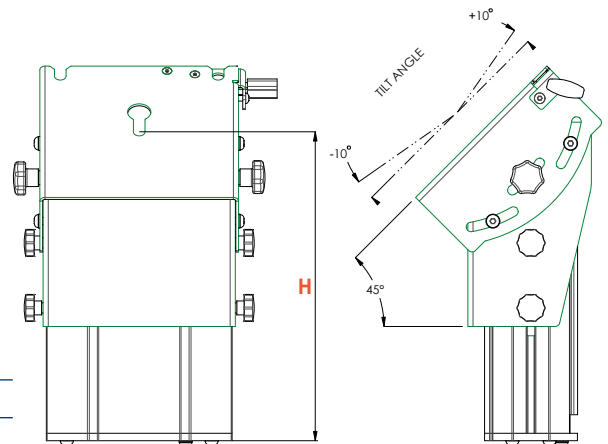
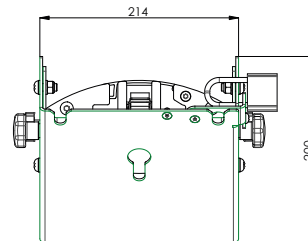

| Article code | Centre display (H) |
|------------------|--------------------|
| S063.0500 | 333 mm |
| S063.0595 | 1033 mm |

ELECTRICAL DIVISIBLE STAND

Display Hoister with flightcase

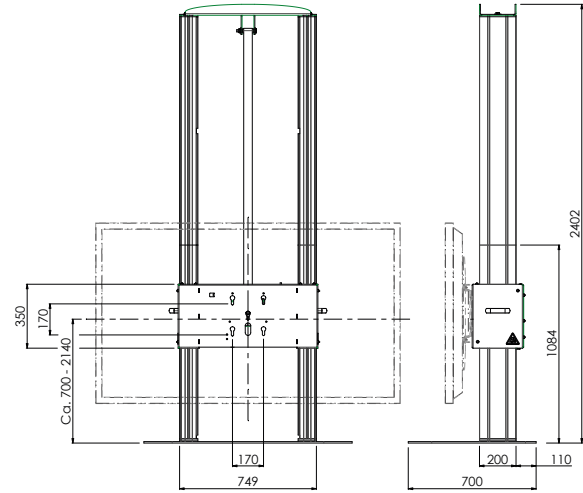





USE AND TRANSPORT OF LARGE FORMAT DISPLAYS MADE EASY

This fully divisible floor stand with its flightcase is the perfect aid to transport and electrically hoist displays with a maximum weight of 120 kg. With the integrated electrical hoist system it is very easy to hoist the monitor out of the flightcase up to the preferred height. Add product 052.5075 with rotation function and you will also be able to rotate the display from landscape to portrait position.

Benefits

- ✓ Easy to install
- ✓ Health & Safety responsible use
- ✓ Effortless hoisting up to 120 kg
- ✓ Perfect aid to transport up to 120 kg load

| | |
|--|---|
|  Colour |  |
|  Max. load | 120 kg |
|  Position | Landscape, Portrait |
|  Required | Display mount below |

| Article code | Inch range |
|---------------------|------------|
| S062.7300-86 | 86 inch |
| S062.7300-98 | 98 inch |

Accessory



DISPLAY MOUNT WITH ROTATION

Universal rental display mount with rotation function and four point coupling. Max. load 160 kg.

Article code

S052.5075

ACCESSORIES

For Light Series Floor Stands & Trolleys

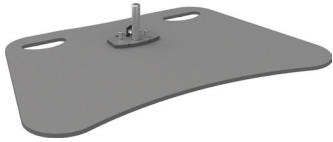

FLOOR PLATE
with pin

S063.8055

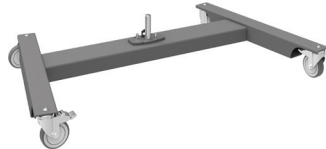

TROLLEY FRAME
with pin

S063.8555



STAND HEAD
with three-point
coupling

S063.8020

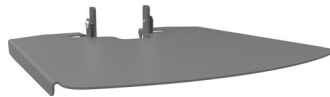

LAPTOP SUPPORT
surface 386x 308 mm

S063.8100

ACCESSORIES

For Heavy Duty Series Floor Stands & Trolleys



HOISTER SYSTEM for divisible floor stand

This hoister enables just one person to hoist a display up to 90 kg out of a flightcase.

After it is taken out of the flightcase, the display is mounted to a fully divisible floor stand and the hoister is removed.

S063.0600



COUPLING BOLT 15 mm, M8x30, ring and nut

S063.1039-M8



front view

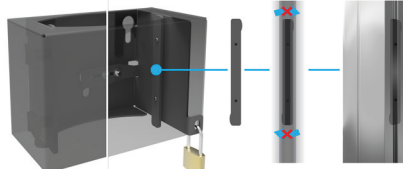

back view

STAND HEAD

For mounting more displays to your floor stand you need an additional stand head and display mount (see page 15).

Stand head contains two clamping strips, designed to offer a perfect fit in the T-slots on both sides of the column, preventing the display from sagging.

S063.1020



FLOOR STAND EXTENSION for fully divisible floor stands

| Article code | Description |
|------------------|------------------------|
| S063.0200 | Stand extension 350 mm |

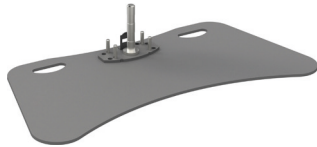

FLOOR PLATES

| Article code | Description |
|------------------|--|
| S063.1010 | Floor plate for one display up to 65 inch, max. 60 kg (with pin) |
| S063.3010 | Floor plate for one display up to 90 inch, max. 85 kg (with pin) |

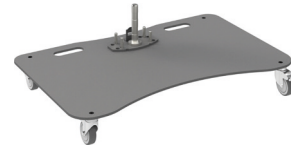

TROLLEY FRAMES

| Article code | Description |
|------------------|--|
| S063.1510 | Trolley frame for one display up to 65 inch, max. 60 kg (with pin) |
| S063.3510 | Trolley frame for one display up to 90 inch, max. 85 kg (with pin) |



LAPTOP SUPPORT

This laptop support can be mounted to the column over the full height.

| Article code | Description |
|------------------|-------------------------|
| S063.0100 | Surface 386 x 308 mm |

DISPLAY MOUNTS

With three point coupling

All our rental mounts are developed with quick and easy installation in mind.

By means of a three-point coupling system all mounts are easily combined with our truss/wall models and floor stands.



✓ Effortless installation

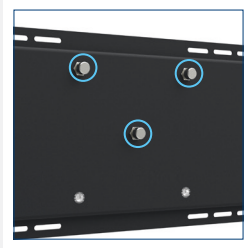

✓ Landscape & portrait

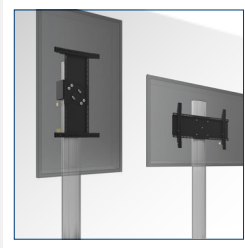

VESA 200 RENTAL DISPLAY MOUNT

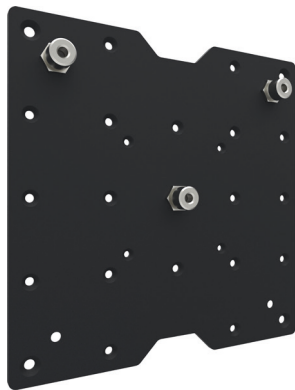

| | | |
|--|------------------|------------------------------|
| | Colour | ● |
| | Max. load | 50 kg |
| | Position | Landscape & Portrait |
| | VESA | VESA 75, 100, 200 x 100, 200 |
| | Note | Three point coupling |

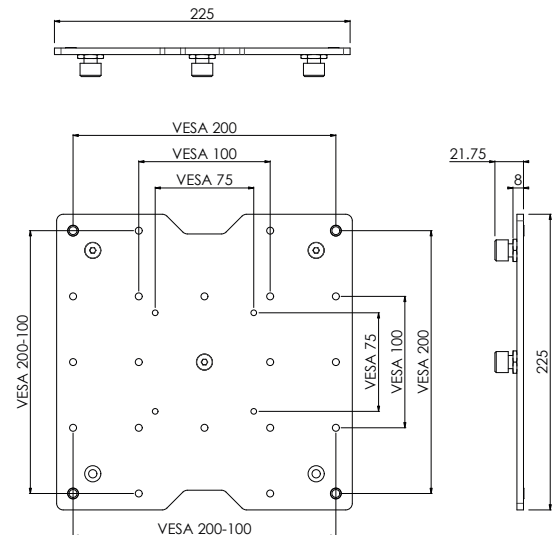

Article code

S063.0300

VESA 200, 400 X 200 RENTAL DISPLAY MOUNT

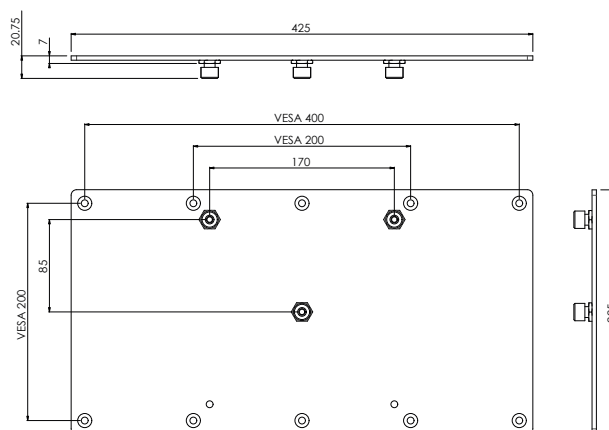
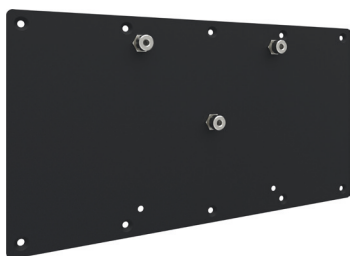

| | | |
|--|------------------|----------------------|
| | Colour | ● |
| | Max. load | 50 kg |
| | Position | Landscape & Portrait |
| | VESA | VESA 200, 400 x 200 |
| | Note | Three point coupling |

Article code

S063.0305

VESA 300(-200), 400(-300/-200) RENTAL DISPLAY MOUNT

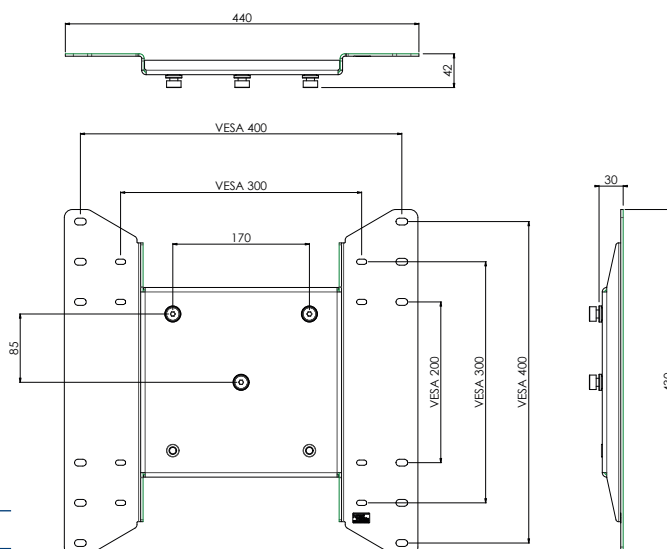

| | | |
|--|------------------|---------------------------------------|
| | Colour | ● |
| | Max. load | 80 kg |
| | Position | Landscape & Portrait |
| | VESA | VESA 300 x 300/200, 400 x 400/300/200 |
| | Note | Three point coupling |

Article code

S063.0310

DISPLAY MOUNTS

With three point coupling

VESA 300, 400(-200) RENTAL DISPLAY MOUNT

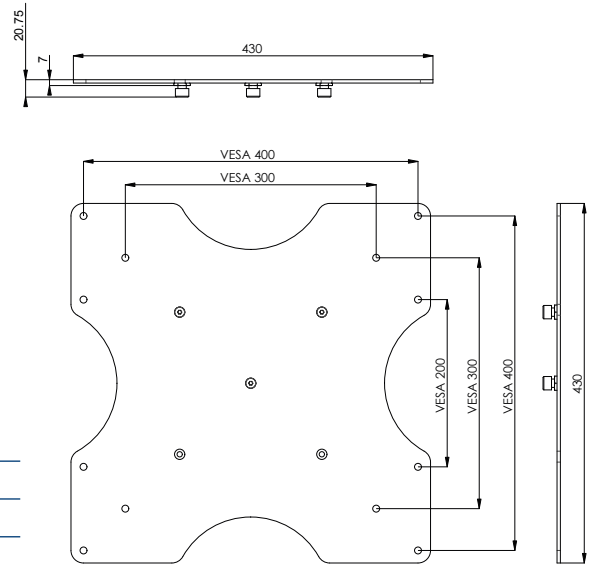
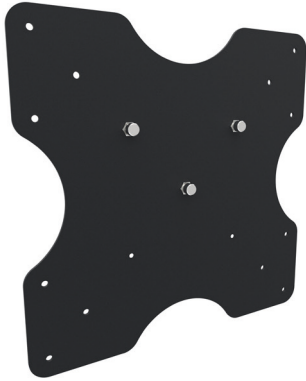

| | | |
|--|-------------------|---|
| | Colour | ● |
| | Max. load | 80 kg |
| | Position | Landscape & Portrait |
| | VESA | VESA 300 x 300, 400 x 400/200 |
| | Note | Three point coupling |
| | Other info | Does not combine with 063.0600 hoist system |

Article code

S063.0315

VESA 600/800 x 400/200 RENTAL DISPLAY MOUNT

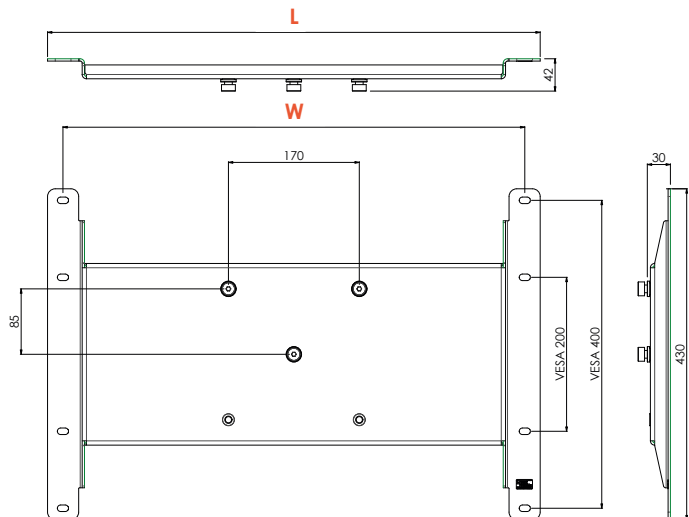
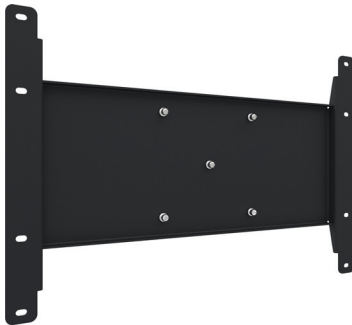

| | | |
|--|------------------|------------------------|
| | Colour | ● |
| | Max. load | 80 kg |
| | Position | Landscape & Portrait |
| | VESA | VESA 600/800 x 400/200 |
| | Note | Three point coupling |

Article code **Width (W)** **Length (L)**

S063.0320

600 mm

640 mm

VESA MAX. 800 X 600 RENTAL DISPLAY MOUNT

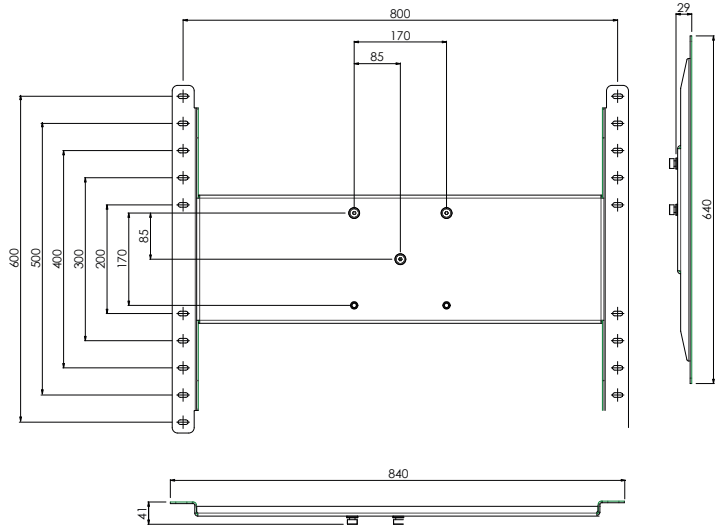
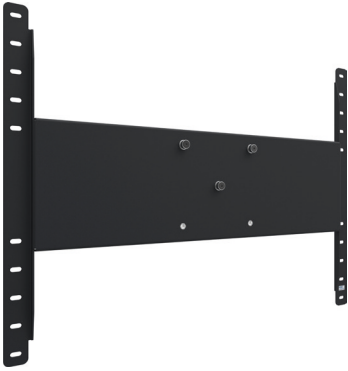

| | | |
|--|------------------|--------------------------------|
| | Colour | ● |
| | Max. load | 160 kg |
| | Position | Landscape & Portrait |
| | VESA | VESA 800 x 600/500/400/300/200 |
| | Note | Three point coupling |

| |
|---------------------|
| Article code |
| S063.0335 |

DISPLAY MOUNT WITH ROTATION

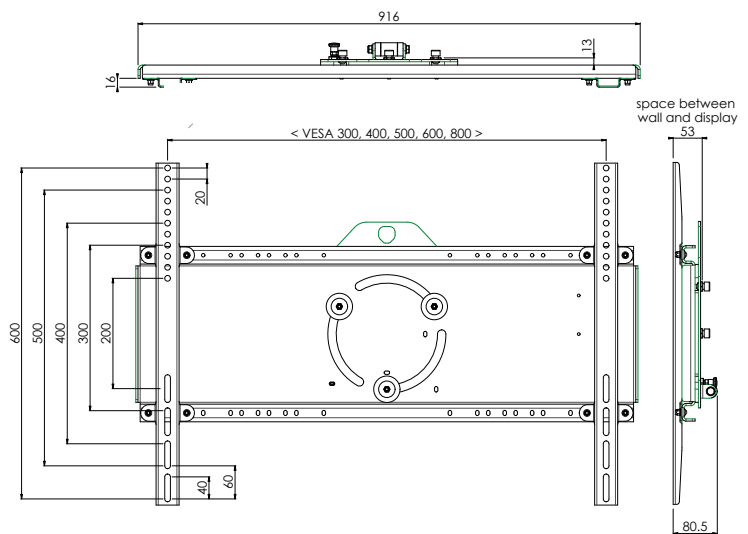
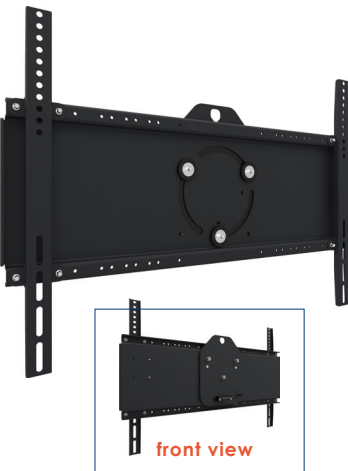

| | | |
|--|------------------|----------------------|
| | Colour | ● |
| | Max. load | 160 kg |
| | Position | Landscape & Portrait |
| | VESA | Max. 800 x 600 mm |
| | Note | Three point coupling |

| Article code | Rotation | Other information |
|------------------|-------------------|--|
| S052.5070 | With rotation 90° | Does not combine with 063.0465 wall-truss module |

TRUSS MOUNTS

Our product assortment includes several solutions to hang a projector from a truss.

The solutions for projectors up to 25 kg include a ball joint, a ball joint clamp incl. handles to fasten without using tools and a bracket with quarter-turn latches. These components together allow a quick and easy installation of a projector. To mount the projector a projector-specific mount or a universal mount (rental version) is required.

The tube sets are electrically insulated, meaning the truss does not need to be taped to prevent screen problems. Furthermore the tube set is fitted with lifting eyes for safety lines.

A projector fine adjustment is added to our assortment for accurate installation. This solution allows a fine adjustment (-20° till $+20^\circ$) and a 90° degrees rotation is included. With our threaded fine adjustment it is possible to continuously pan and tilt the projector. This set allows direct mounting of the projector with its projector-specific mount or using a mount with quarter-turn latches in between. The projector fine adjustment can be mounted to a truss using two trigger clamps.



TRUSS MOUNTS

With ball joint

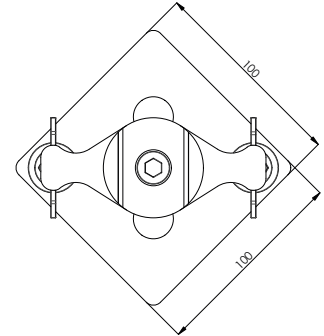
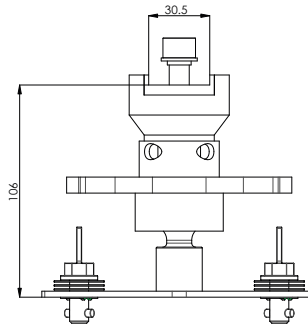

RENTAL SET 1, 130 MM FIXED FOR TRIGGER CLAMP, EXCLUDING MOUNT

| | | |
|--|--------------------|--|
| | Colour | ● |
| | Max. load | 30 kg |
| | Note | Tilt +20° / -20°, rotation 360° |
| | Required | Projector-specific/universal mount |
| | Accessories | See from page 22 |
| | Other info | Electrical insulation excluding Doughty Trigger Clamp (003.1128) |

| |
|---------------------|
| Article code |
| S002.1641 |

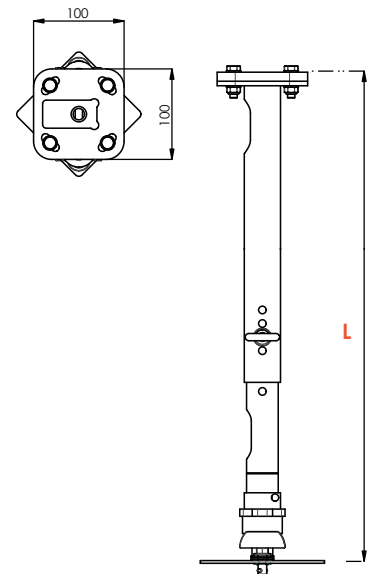

RENTAL SET 2 - 3, ADJUSTABLE EXCLUDING MOUNT

| | | |
|--|--------------------|--|
| | Colour | ● |
| | Max. load | 30 kg |
| | Note | Tilt +20° / -20°, rotation 360° |
| | Required | Projector-specific/universal mount |
| | Accessories | See from page 22 |
| | Other info | Electrical insulation excluding Doughty Trigger Clamp (003.1128) |

| Article code | Description | Length (L) |
|------------------|-------------|---------------|
| S002.1660 | Set 2 | 463 - 713 mm |
| S002.1661 | Set 3 | 713 - 1163 mm |

LIGHTWEIGHT TRUSS MOUNTS

With fine adjustment

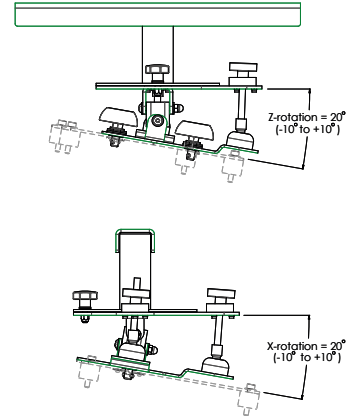
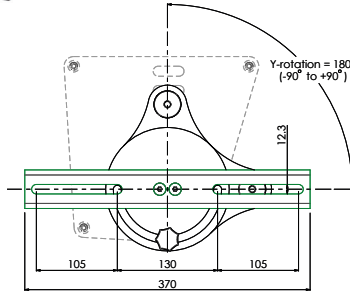

PROJECTOR FINE ADJUSTMENT EXCL. BRACKET, EXCL 2X TRIGGER CLAMP

| | | |
|--|--------------------|--|
| | Colour | ● |
| | Max. load | 25 kg |
| | Required | Projector-specific mount |
| | Accessories | See from page 22 |
| | Other info | Electrical insulation excluding Doughty Trigger Clamp (003.1128) |

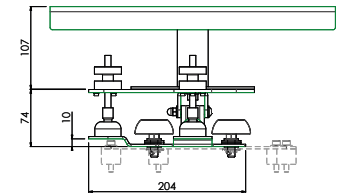

Article code

S002.1650

HEAVY DUTY TRUSS MOUNTS

With fine adjustment

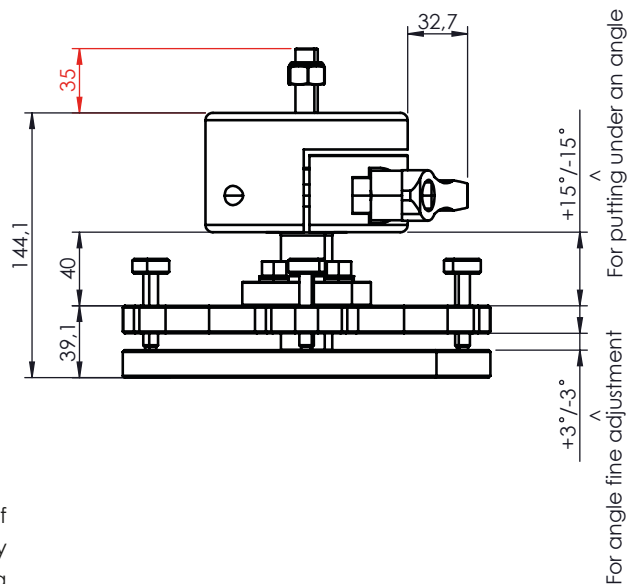

RENTAL MOUNT 150 MM FOR PROJECTOR MAX. 250 KG

Our rental mounts ensure a quick and easy installation of projectors in rental situations. The 002.4600 is a heavy duty projector mount for installation of projectors with a maximum weight of 250 kg in a truss.

It offers a tilt function of +15° until -15° and a further fine adjustment +3° until -3°. The rental mount has to be combined with a projector-specific mount, please contact us for the one that fits your projector.

The mounting pattern 100 x 100 mm makes it standard suitable to the most Panasonic and Barco stack frames.

This rental mount is thoroughly tested and has TÜV certification.

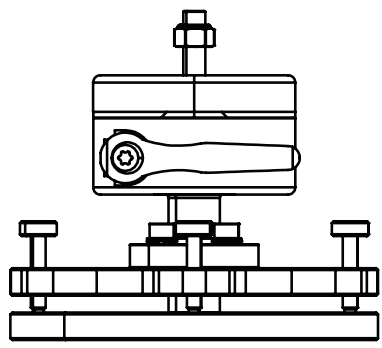

| | | |
|--|--------------------|--------------------------|
| | Colour | ● |
| | Max. load | 250 kg |
| | Required | Projector-specific mount |
| | Note | Rotation 360° |
| | Accessories | See from page 22 |

| |
|---------------------|
| Article code |
| S002.4600 |

ACCESSORIES

For truss mounts



DOUGHTY TRIGGER CLAMP for rental set 1-3 and 002.1650

This Doughty Trigger Clamp can be used for truss mounting with the SmartMetals rental mount (002.16xx, and the wall-truss module (art. nr.: 063.0460).

S003.1128



UNIVERSAL MOUNT for rental set 1-3, max. Ø 378 mm

Besides the projector specific mount (custom-made to projector brand and type) a universal mount is available as well.

S002.1003

TÜV & DGUV Certified

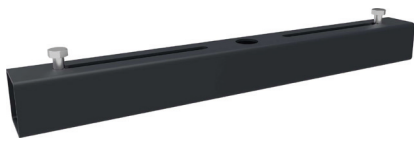

TRUSS MOUNTING BAR for rental mount 002.4600

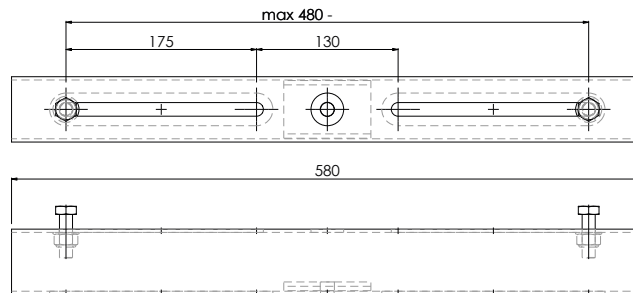





S002.4610

STACK FRAMES

SMALL SERIES



TÜV & DGUV Certified

-  **Colour** ●
-  **Max. load** 100 kg
-  **Required** Projector mount (excl.), pls contact us
-  **Accessories** See page 25
-  **Other info** Max. stacked weight under top frame 275 kg

| Article code | Description | Max. projector size (W x L x H) |
|------------------|-------------|---|
| S112.4200 | Small 200 | 500 x 560 x 200 mm |
| S112.4210 | Small 210 | 590 x 500 x 210 mm <i>(deviating specifications, please see below)</i> |

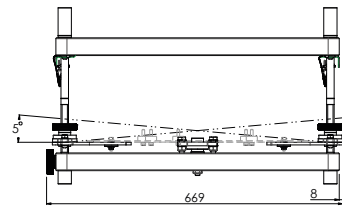
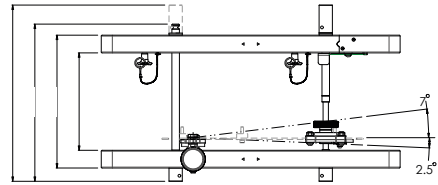
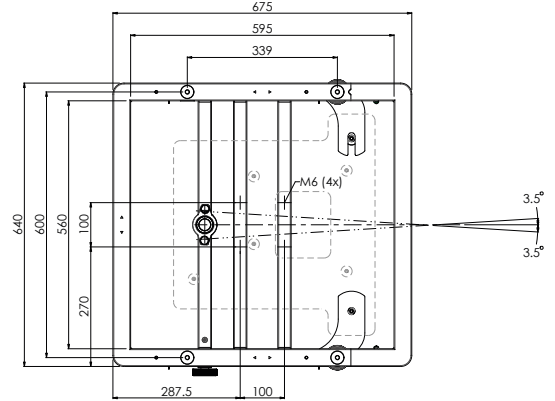

Specifications for 112.4210 only:

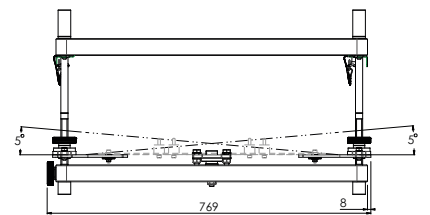
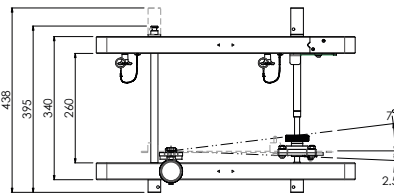
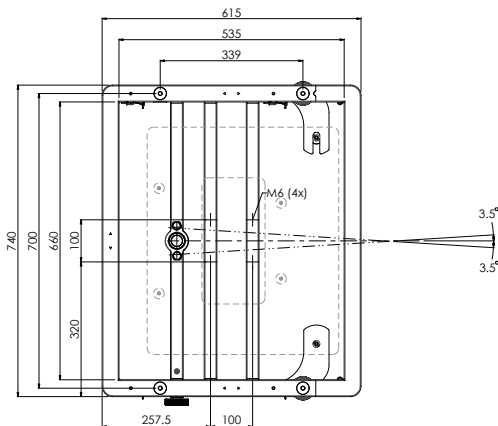

ACCESSORIES

For stack frames



**DOUGHTY
TRIGGER
CLAMP**

S003.1128



**PROJECTOR
SPECIFIC
MOUNT**

S112.1001

TÜV & DGUV Certified



**STACK FRAME
CLAMP
(40 x 40 tubes)**

S112.1019

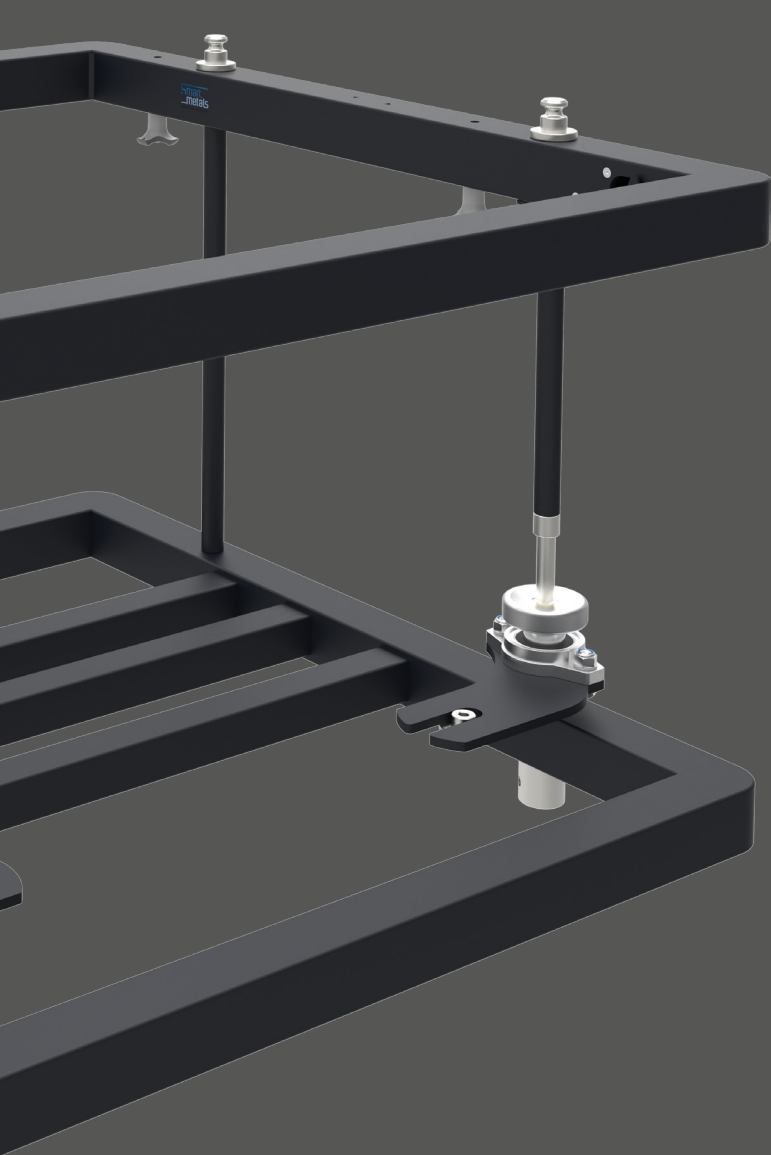

Contact details

BENELUX

Vogel's Professional Benelux
Afrikalaan 29
5232 BD DEN BOSCH
The Netherlands
+ 31 (0)88 587 88 50

GERMANY/AUSTRIA/SWITZERLAND

Vogel's Products B.V.
In den Fichten 34
32584 LÖHNE
Germany
+ 49 (0)5731 869 170

SPAIN

Vogel's Products Iberica S.L.U.
Pl. Vapor Vell de Sants, Nº 1, 3-3
Edifici Filatures
Colònia Güell - Sta Coloma de
Cervelló Barcelona 08690
Spain
+ 34 (0)934 86 99 70

OTHER COUNTRIES

Vogel's Products B.V.
Hondsruglaan 93
5628 DB EINDHOVEN
The Netherlands
+ 31 (0)40 264 74 00

Email & Website

professional@vogels.com
www.vogels.com
www.smartmetals.eu

2024 - Product Catalogue - Rental

The information contained in this catalogue is to be used only as a guide to assist with product selection. The products features and technical drawings set forth in this catalogue are subject to change due to product innovations. Please consider information on our website www.vogels.com in any case leading.

