



FM1544B Floor stand, fixed to the floor

Article number (SKU)
Colour

7952010
Black

Key Benefits

- Stylish high-end design
- Cable management
- Quick and easy installation

Floor mounted kit FM1544

Display size: Fitment: 400x400Max. load: 80 kg - 176 lbs Kit consists of: • 1x PFFF 7060 Floor plate extra large • 1x PUC 2715 pole 150 cm • 1x PFB 3405 Interface bar • 1x PFS 3304 Interface display strips

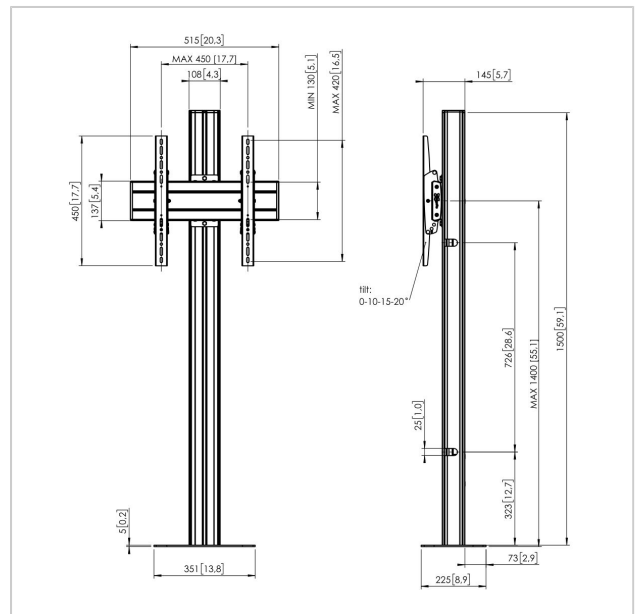



FM1544B Floor stand, fixed to the floor

www.vogels.com

VOGEL'S HOLDING BV 2019 (c) All rights reserved.
Subject to printing errors, technical and price amendments.
Date:2020-08-26

Specifications

Product type number	FM1544
Article number (SKU)	7952010
Colour	Black
EAN single box	8712285332869
Height	1500
Width	351
Depth	255
TÜV certified	Yes
Tilt	Tilt up to 20°
Guarantee	5 years
Max. weight load (kg)	80
Min. hole pattern	100mm x 100mm
Max. hole pattern	420mm x 450mm
Max. bolt size	M8
Max. height of interface (mm)	450
Max. width of interface (mm)	515
Max. distance to floor - center display (mm)	1400
Max. horizontal hole pattern (mm)	420
Max. screen size (inch)	65
Max. vertical hole pattern (mm)	450
Min. horizontal hole pattern (mm)	100
Min. vertical hole pattern (mm)	100
Universal or fixed hole pattern	Universal